

## High Power SPT<sup>+</sup> & Lugged Type IGBT Module

### Description

DAWIN'S IGBT 7DM-2 Package devices are optimized to reduce losses and switching noise in high frequency power conditioning electrical systems. These IGBT modules are ideally suited for power inverters, motors drives and other applications where switching losses are significant portion of the total losses.

### Features

- ☞ High Speed Switching
- ☞  $BV_{CES} = 1200V$
- ☞ Low Conduction Loss :  $V_{CE(sat)} = 1.8V$  (typ.)
- ☞ Fast & Soft Anti-Parallel FWD
- ☞ Short circuit rated : Min. 10uS at  $T_C=100^\circ C$
- ☞ Reduced EMI and RFI
- ☞ Isolation Type Package

### Applications

Motor Drives, High Power Inverters, Welding Machine, Induction Heating, UPS , CVCF, Robotics , Servo Controls, High Speed SMPS

### Equivalent Circuit and Package

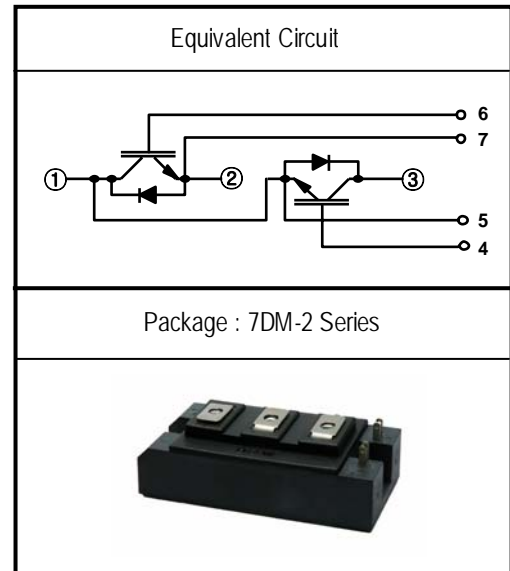

Please see the package out line information

### Absolute Maximum Ratings @ $T_j=25^\circ C$ (Per Leg)

Symbol	Parameter	Conditions	Ratings	Unit
$V_{CES}$	Collector-Emitter Voltage	-	1200	V
$V_{GES}$	Gate-Emitter Voltage	-	$\pm 20$	V
$I_C$	Collector Current	$T_c = 25^\circ C$	275	A
		$T_c = 80^\circ C$	200	A
$I_{CM(1)}$	Pulsed Collector Current	-	400	A
$I_F$	Diode Continuous Forward Current	$T_c = 100^\circ C$	200	A
$I_{FM}$	Diode Maximum Forward Current	-	400	A
$T_{SC}$	Short Circuit Withstand Time	$T_c = 100^\circ C$	10	uS
$P_D$	Maximum Power Dissipation	$T_c = 25^\circ C$	1350	W
$T_j$	Operating Junction Temperature	-	-40 ~ 150	$^\circ C$
$T_{stg}$	Storage Temperature Range	-	-40 ~ 125	$^\circ C$
$V_{iso}$	Isolation Voltage	AC 1 minute	2500	V
TL	Maximum Lead Temp. for soldering Purposes, 1/8" from case for 9 seconds	-	260	$^\circ C$
	Mounting screw Torque :M6	-	4.0	N.m
	Power terminals screw Torque :M5	-	2.0	N.m

**Electrical Characteristics of IGBT @  $T_C=25^\circ\text{C}$  (unless otherwise specified)**

Symbol	Parameter	Conditions	Values			Unit
			Min.	Typ.	Max.	
$BV_{CES}$	C - E Breakdown Voltage	$V_{GE} = 0V, I_C = 1.0mA$	1200	-	-	V
$\Delta BV_{CES}/\Delta T_J$	Temperature Coeff. of Breakdown Voltage	$V_{GE} = 0V, I_C = 1.0mA$	-	0.6	-	V/°C
$V_{GE(th)}$	G - E threshold voltage	$I_C = 5.0mA, V_{CE} = V_{GE}$	5	-	8	V
$I_{CES}$	Collector cutoff Current	$V_{CE} = 1200V, V_{GE} = 0V$	-	-	2.0	mA
$I_{GES}$	G - E leakage Current	$V_{GE} = \pm 20V$	-	-	$\pm 300$	nA
$V_{CE(sat)}$	Collector to Emitter saturation voltage	$I_C=200A, V_{GE}=15V @T_C= 25^\circ\text{C}$	-	1.8	2.75	V
		$I_C=200A, V_{GE}=15V @T_C=100^\circ\text{C}$	-	2.0	-	V
$C_{ies}$	Input capacitance	$V_{GE} = 0V, f = 1MHz$	-	15	-	nF
$C_{oes}$	Output capacitance	$V_{CE} = 25V$	-	1.1	-	nF
$C_{res}$	Reverse transfer capacitance		-	0.7	-	nF
$t_{d(on)}$	Turn on delay time	$V_{CC} = 600V, I_C = 200A$	-	180	-	nS
$t_r$	Turn on rise time	$V_{GE} = \pm 15V$	-	85	-	nS
$t_{d(off)}$	Turn off delay time	$R_G = 5.1\Omega$	-	520	-	nS
$t_f$	Turn off fall time	Inductive Load=60nH	-	100	-	nS
$E_{on}$	Turn on Switching Loss		-	13	-	mJ
$E_{off}$	Turn off Switching Loss		-	9	-	mJ
$E_{ts}$	Total Switching Loss		-	22	-	mJ
$T_{sc}$	Short Circuit Withstand Time	$V_{CC} = 600V, V_{GE} = \pm 15V$ $R_G = 5.1\Omega @T_C = 100^\circ\text{C}$	10	-	-	$\mu\text{S}$
$Q_g$	Total Gate Charge	$V_{CC} = 600V$	-	1400	-	nC
$Q_{ge}$	Gate-Emitter Charge	$V_{GE} = \pm 15V$	-	250	-	nC
$Q_{gc}$	Gate-Collector Charge	$I_C = 200A$	-	800	-	nC

**Electrical Characteristics of FRD @  $T_c=25^\circ\text{C}$  (unless otherwise specified)**

Symbol	Parameter	Conditions	Values			Unit	
			Min.	Typ.	Max.		
$V_{FM}$	Diode Forward Voltage	$I_F=200A$	$T_c = 25^\circ\text{C}$	-	2.3	3.0	V
			$T_c = 100^\circ\text{C}$	-	2.1	-	
$t_{rr}$	Diode Reverse	$I_F=200A, V_R=600V$ $di/dt= -200A/\mu S$	$T_c = 25^\circ\text{C}$	-	200	-	nS
	Recovery Time		$T_c = 100^\circ\text{C}$	-	220	-	
$I_{rr}$	Diode Peak Reverse		$T_c = 25^\circ\text{C}$	-	75	-	A
	Recovery Current		$T_c = 100^\circ\text{C}$	-	90	-	
$Q_{rr}$	Diode Reverse		$T_c = 25^\circ\text{C}$	-	3000	-	nC
	Recovery Charge		$T_c = 100^\circ\text{C}$	-	12500	-	

**Thermal Characteristics and Weight**

Symbol	Parameter	Conditions	Values			Unit
			Min.	Typ.	Max.	
$R_{\theta JC}$	Junction-to-Case(IGBT Part, Per 1/2 Module)		-	-	0.09	$^\circ\text{C}/W$
$R_{\theta JC}$	Junction-to-Case(DIODE Part, Per 1/2 Module)		-	-	0.22	$^\circ\text{C}/W$
$R_{\theta CS}$	Case-to-Sink (Conductive grease applied)		0.025	-	-	$^\circ\text{C}/W$
Weight	Weight of Module		-	-	250	g

**Performance Curves**

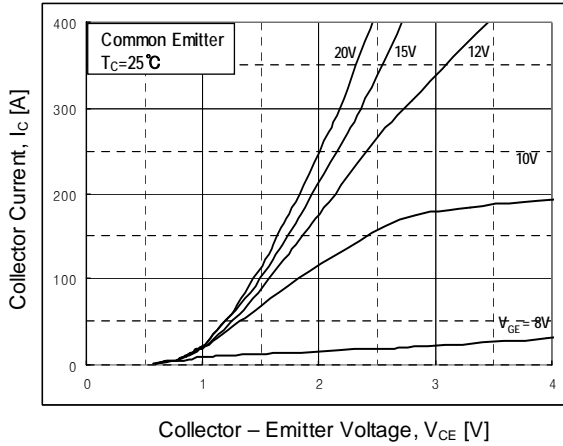

**Fig 1. Typical Output characteristics**

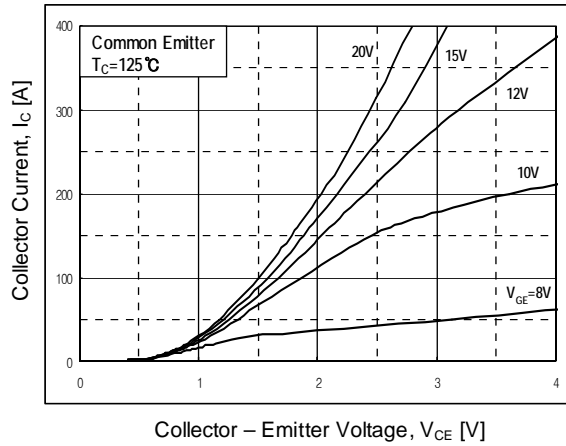

**Fig 2. Typical Output characteristics**

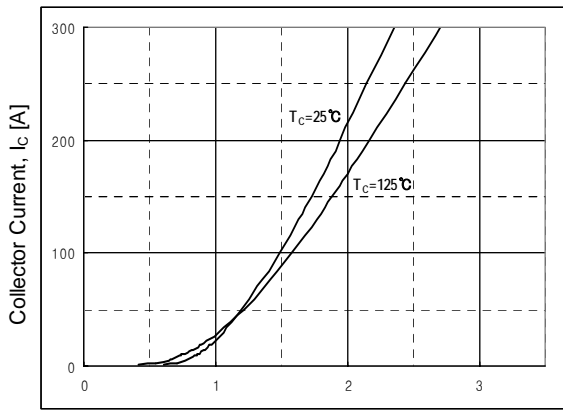

**Fig 3. Typical Saturation Voltage characteristics**

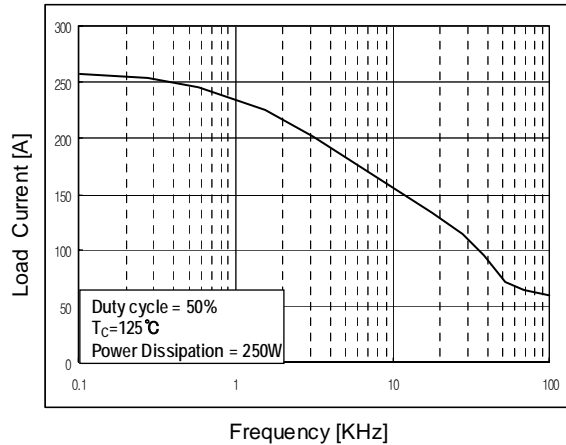

**Fig 4. Load Current vs. Frequency**

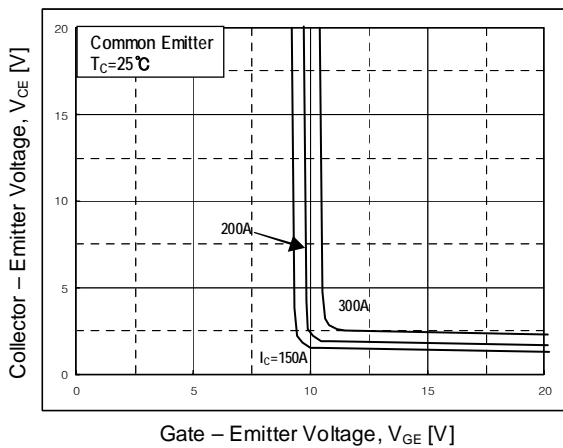

**Fig 5. Typical Saturation Voltage vs.  $V_{GE}$**

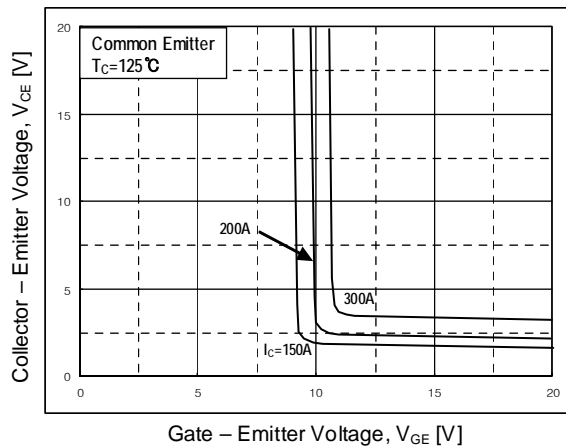

**Fig 6. Typical Saturation Voltage vs.  $V_{GE}$**

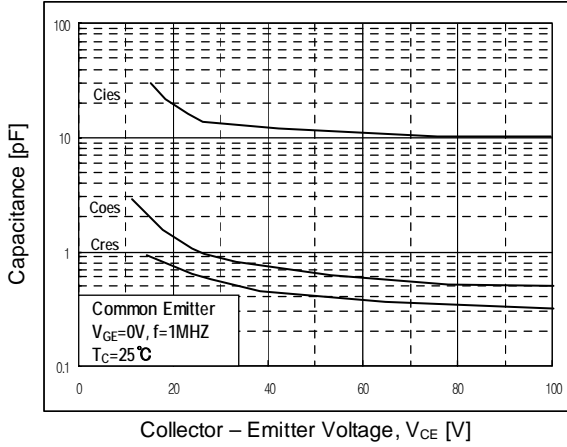

**Fig 7. Capacitance characteristics**

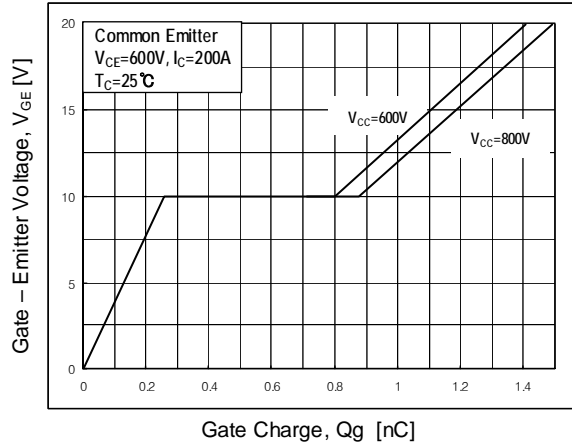

**Fig 8. Gate Charge characteristics**

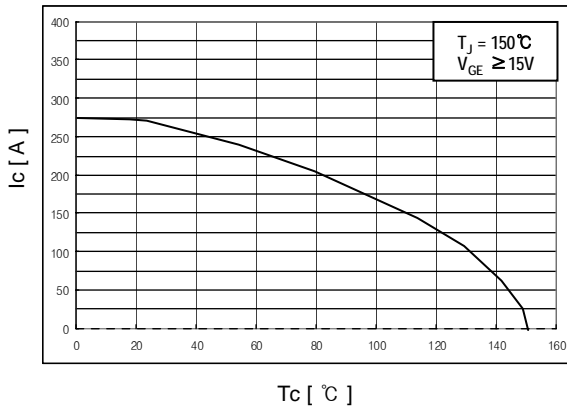

**Fig 9. rated Current vs. Case Temperature**

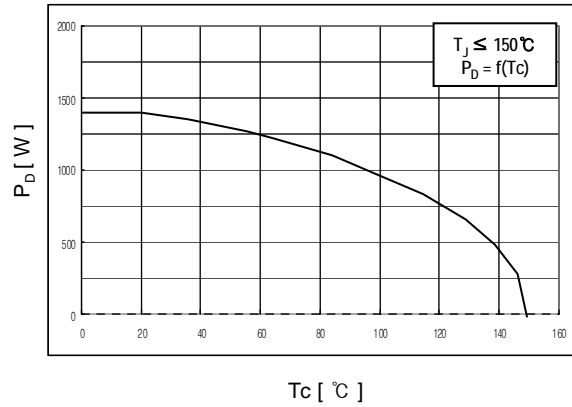

**Fig 10. Power Dissipation vs. Case Temperature**

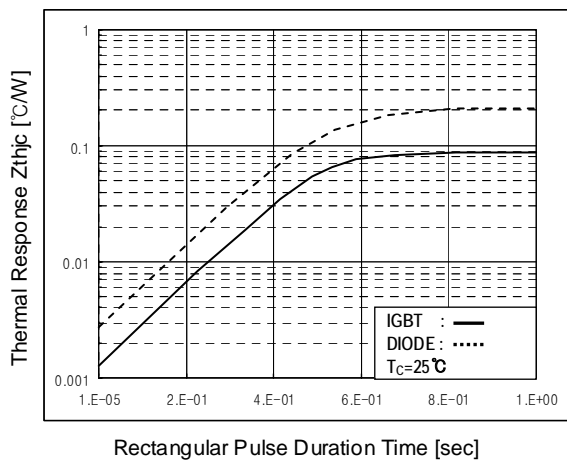

**Fig 11. Transient Thermal Impedance**

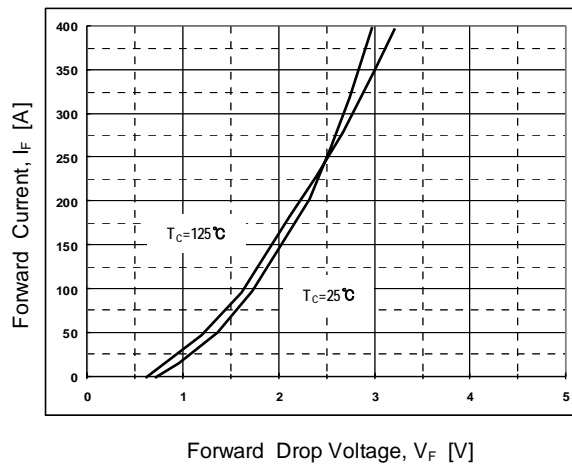

**Fig 12. Forward characteristics**

Package Out Line Information

7DM-2

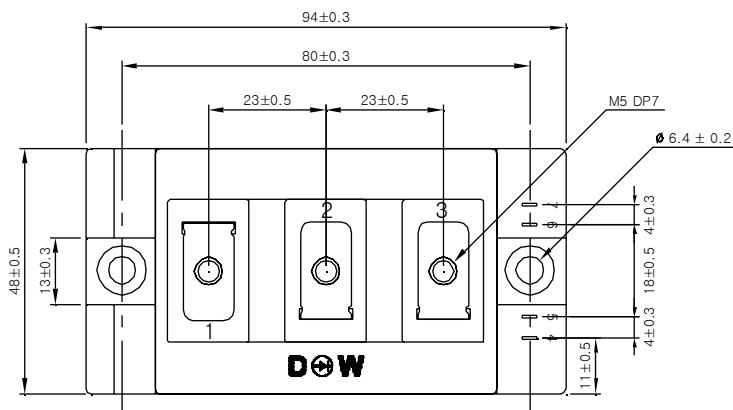

Dimensions in mm

